

MICRO-USB  
LT32U03A处于升级状态时，主控设备不可通过串口向其发送数据

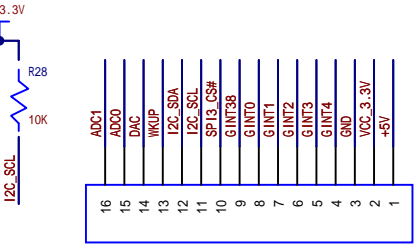

J2 Header 1x16

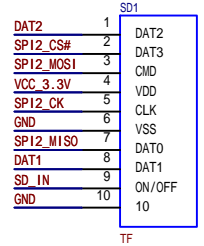
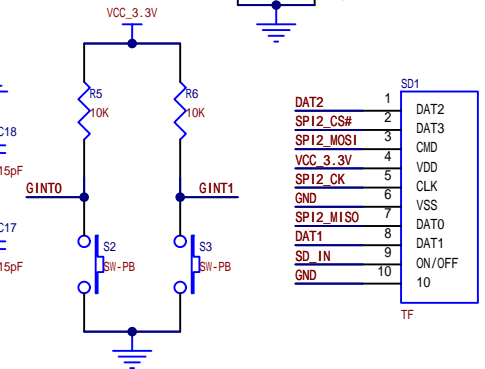
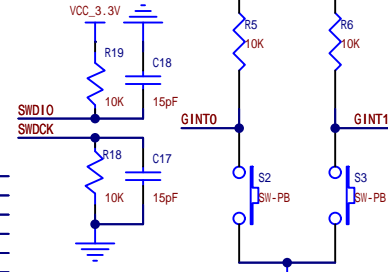
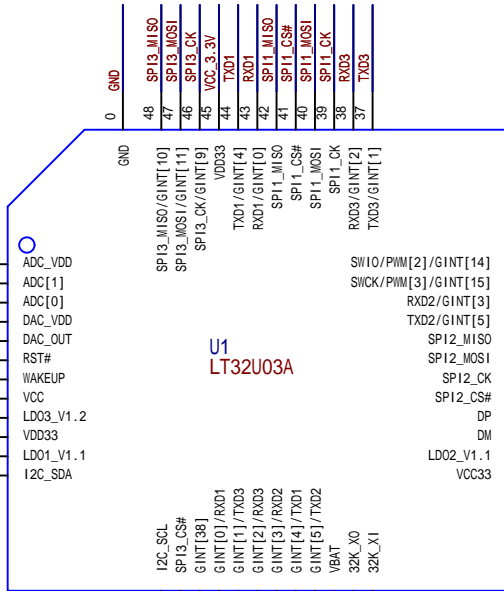
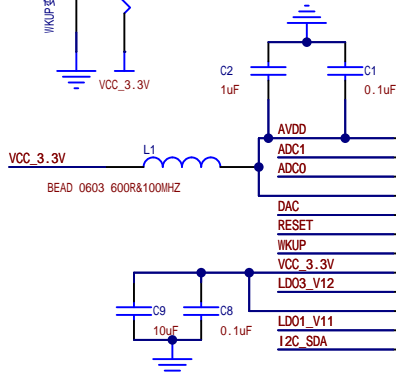
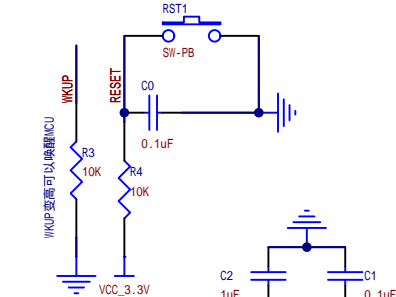
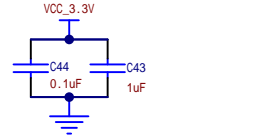
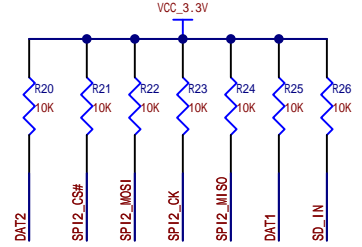
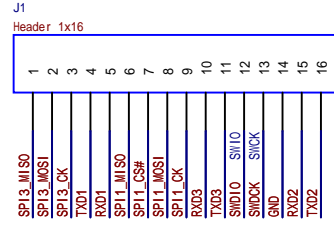
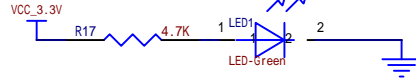
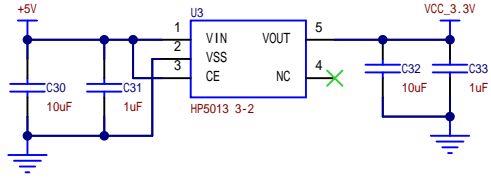
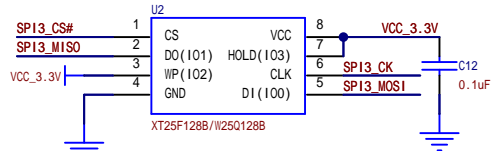
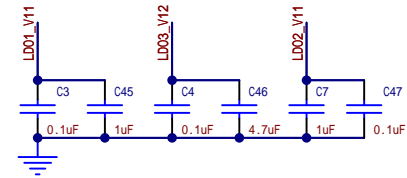
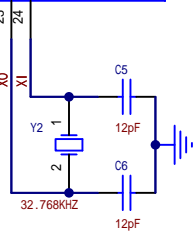

PCB layout时，FLASH应离LT32U03A尽量近