

USB

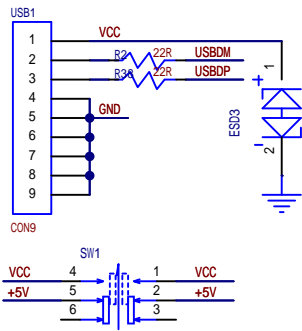

SWD

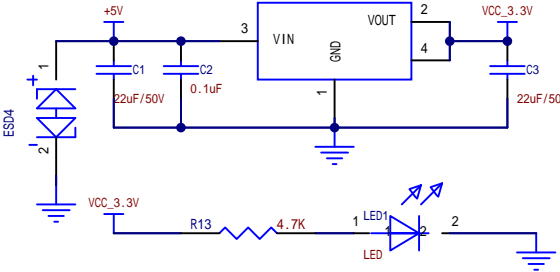
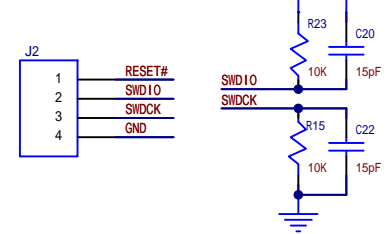

SD卡

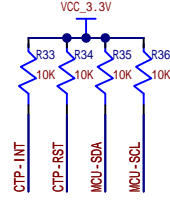
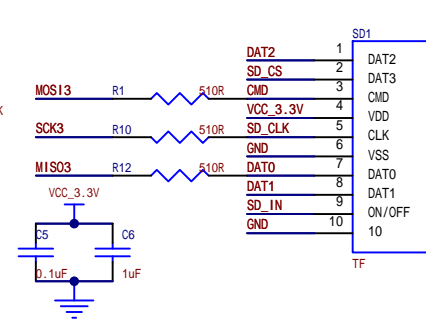

LT32U03C

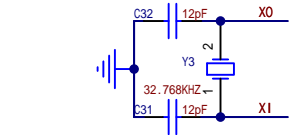
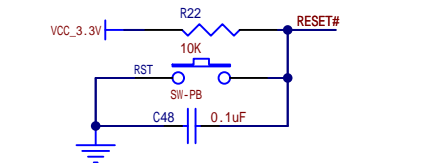
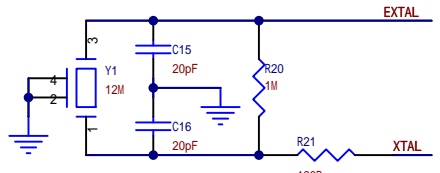
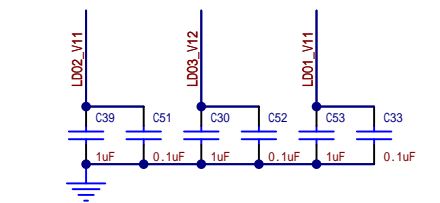
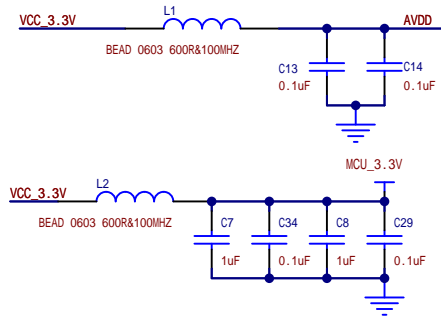

RTC

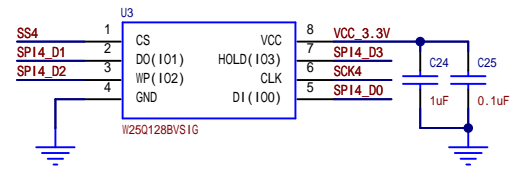
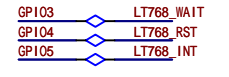
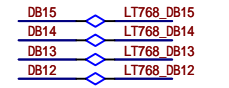
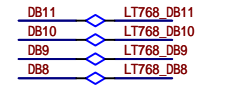
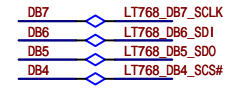
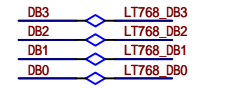
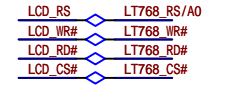
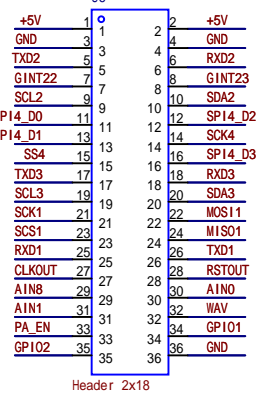
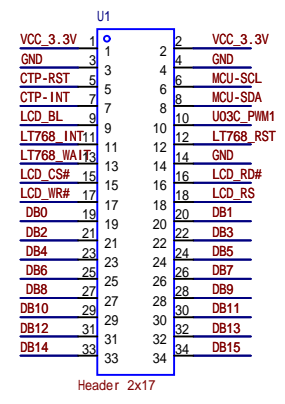
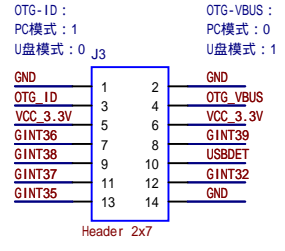
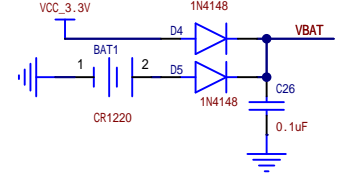

PCB layout时, FLASH应离LT32U03C尽量近

